

アルカロイド - 酢酸緩衝液
Alkaloids - acetate buffer

J021010D

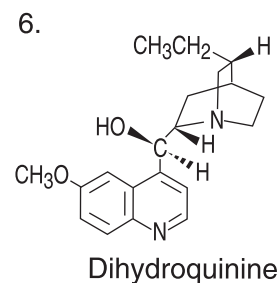
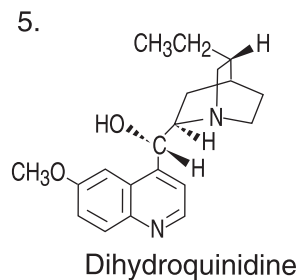
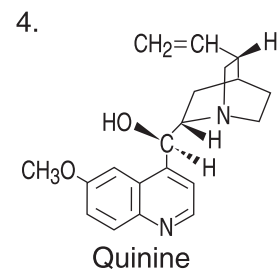
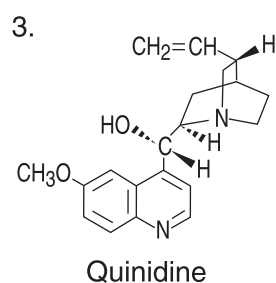
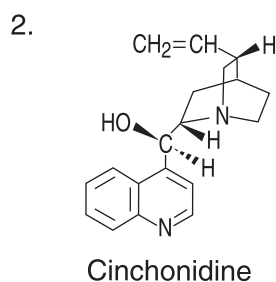
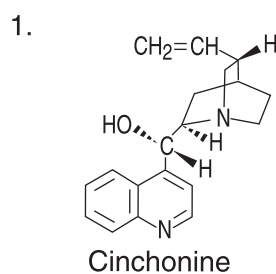
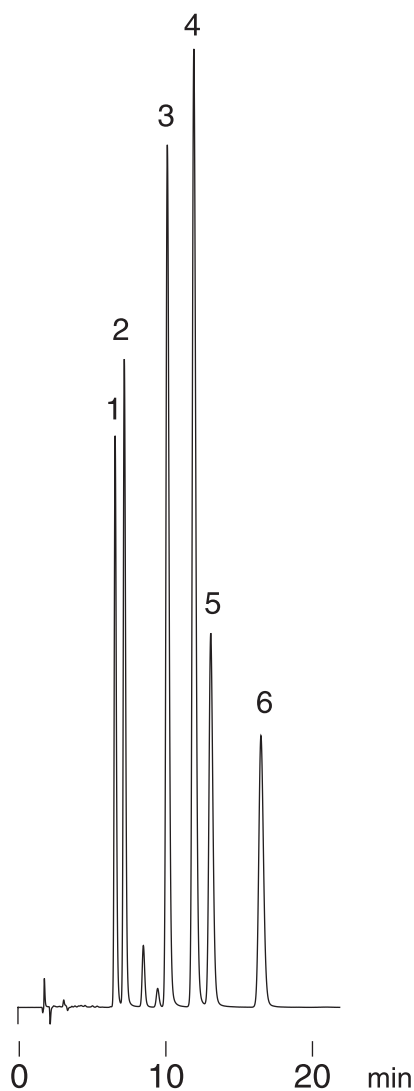

Column	: Hydrosphere C18 (5 μ m, 12nm) 150 \times 4.6 mm I.D.
Eluent	: 20mM CH ₃ COOH-CH ₃ COONH ₄ (pH4.9)/methanol (65/35)
Flow rate	: 1.0 mL/min
Temperature	: 37 $^{\circ}$ C
Detection	: UV at 235 nm, 0.08 AUFS
Injection	: 10 μ L (0.01~0.03 mg/mL)